



MARELA water heater



MARELA 10/17

MARELA 15/23

MARELA 30/40

Installation and maintenance instructions

Table of contents

Warning and safety instructions (explanation)	4
Installation	4
identification plate	5
technical data	6
overview MARELA-series	6
Heating controller MARELA-Series	7
Interference lights	8
Domestic hot water heating	8
expansion tank (optional)	8
hybrid-heating with electric power (optional)	8
How electric heating works	9
Connection room thermostat with NO contact to MARELA series boiler	9
Overview of cable connections between components and control box	10
Antifreeze liquid for heating water (BIO-GLYKOL)	11
Oil supply / oil filter	11
Combustion air supply for MARELA - series	12
Exhaust pipe for MARELA-series	12
Burner components	12
Flame detector	12
Oil hoses (<i>pair</i>)	12
Oil pump motor	13
Fan control	13
Ignition electrodes	13
Ignition transformer	13
Radial fan	13
Oil pump	13
Flame tube	13
Air pressure switch	13
Control unit	14

Table of contents

Pipe connection group components	15
Circulating pump	15
Plate heat exchanger	15
3-way zone valve	15
Flow switch	15
temperature sensor	15
Mixer	15
Safety assembly	15
Door and boiler insulation	15
boiler door cord	15
Maintenance preparation	16
Change oil filter	16
Clean boiler	17
Set pump pressure	17
mixing cartridge control	18
nozzle	18
Electrical schematics of controller	19
Room thermostat - WLAN (optional)	20
Room thermostat	20
About the thermostat	20
Installation	21
Homescreen quick reference	22
operation	22
Default settings for program schedule	23
Change the system settings	23

Warning and safety instructions (explanation)

The following table explains the used colors, words and their meaning used in this manual.

classification of the signal word according to ANSI Z535.4	
signal word	identification of hazard
NOTICE	Notice: [this header is] preferred to address practices not related to personal injury. Used for property damage.
CAUTION!	Caution: Indicate[s] a hazardous situation which, if not avoided, could result in minor or moderate injury.
WARNING!	Warning: Indicate[s] a hazardous situation which, if not avoided, could result in death or serious injury.
DANGER!	Danger: Indicate[s] a hazardous situation which, if not avoided, will result in death or serious injury.

Installation

WARNING: **Electric current hazard!**

The device may only be operated on properly installed single sockets with protective contact. Do not pull the power cord out of the socket by pulling the cable. Always grasp the housing of the power plug. The burner elements and connections have 230 V voltage. The unit must be secured on the vehicle side with a protective contact plug. The power supply must meet the requirements of the unit.



WARNING:

Switching on the heating system without heating water can destroy the heating system.

CAUTION:

To avoid frost damage, the heating system must be filled with an anti-freeze liquid. The heating system must be drained of service water as necessary.

NOTICE:

The flow temperature of heated heating water can be freely set before commissioning.

WARNING:

To prevent misuse and the associated hazards, render your old device unusable before disposing of it. To do this, disconnect the device from the mains supply and remove the mains connection cable from the device. For the disposal of the device, observe the regulations applicable in your country and in your municipality.

Disposal of old devices

The discarded device must be disposed of at the end of its service life in accordance with national regulations. It is recommended to contact a company specialized in disposal or to contact the disposal department of your municipality.

DANGER: Death or serious injury due to improper installation or repair.
Improper installation or improper repair can cause a fire or the leakage of deadly carbon monoxide leading to serious injury or death.
The person to install and repair the heating system must have completed a SCHEER training course.
 Always follow all installation and repair instruction.
 Heed all warning and safety signs.
 All required technical documentations, tools, and equipment must be available in the vehicle for installation and repair.

NOTICE: Cancellation of all warranty and liability claims!
 Not following the required installation conditions will lead to the loss of all warranty and liability claims!
 Installation must comply with governing statutory regulations listed on **page 4**.
 If the water heater is to be operated in a separately installed heating system, prior to installation an installation planning report must always be submitted to SCHEER for approval. If this approval is not obtained, all warranty and liability claims will be void.

NOTICE:
 SCHEER rejects any liability for defects and damage, which are due to installation or repair by unauthorized and untrained persons.

NOTICE: Check the installation situation of the relevant boat type.
Installation position:
 The heater must be installed in as low a position as possible to allow the heater and circulating pump to be bled automatically. This is particularly important as the circulating pump is not self-priming.

Initial commissioning

Refer to the safety instructions in the operating and maintenance manual!
 Read and understand all operating and maintenance instructions before starting the heater.
 After installing the heater bleed the water system and the fuel supply system carefully.
 Follow the instructions supplied by the vehicle manufacturer for this purpose.
 Check the electrical connections for the correct polarity.
 Conduct a test run of the heater to check all the water and fuel connections for leaks and ensure that they are tight and secure. In case of an error during the test run or normal operation refer to the trouble-shooting table and fix it.
 Tighten all pipe union connections after the first full heat up operation. Please send a copy of the start-up protocol to SCHEER.

identification plate

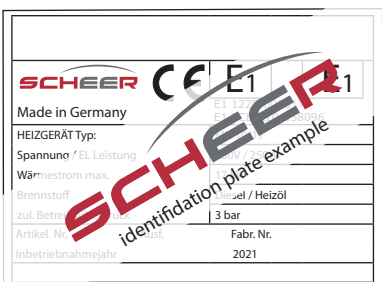

Fig. identification plate example

The model and identification plate must be protected from damage and must be clearly visible when the heater is installed (otherwise a duplicate model and identification plate must be used)

technical data

		MARELA 10/17 Art. 077998	MARELA 15/23 Art. 077997	MARELA 30/40 Art. 077999
operating power	kW	10/17	15/23	30/40
dimensions (w / h / d) **	cm	67 / 49 / 62	72 / 53 / 66	80 / 61 / 74
efficiency	%	93	93	94
fresh water heating		optional (combi) plate heat exchanger		
boiler volume	l	18	23	37
fuel		diesel / heating oil and GTL/BTL (DIN EN 15940)		
oil nozzle		0.30 / 60°SCD	0.35 / 60° SCD	0.65 / 60° SCD
rated voltage	V	230	230	230
Power consumption (operation)*	A	0,94	0,94	0,94
exhaust temperature	°C	150 - 210	145 - 205	145 - 205
Max. operating pressure	bar	3	3	3
exhaust	mm	Ø 35	Ø 50	Ø 50

* assumption: 10 min. burner operation within one heating hour including boiler circulating pump. Without pumps for other heating circuits.

** dimensions without control box / pipe group / expansion tank

The MARELA water heaters are approved for the fuels „diesel“ and „heating oil“ as well as GTL/BTL. Other fuels must be approved by the manufacturer SCHEER before use. The heaters are designed for 230 volts.

The connection in the vehicle is to be fed by the vehicle's battery via an inverter approved for road traffic within the scope of the ECE regulations.

Alternatively, the heater can also have a 230 V direct feed (e.g. direct feed from the campsite).

overview MARELA-series

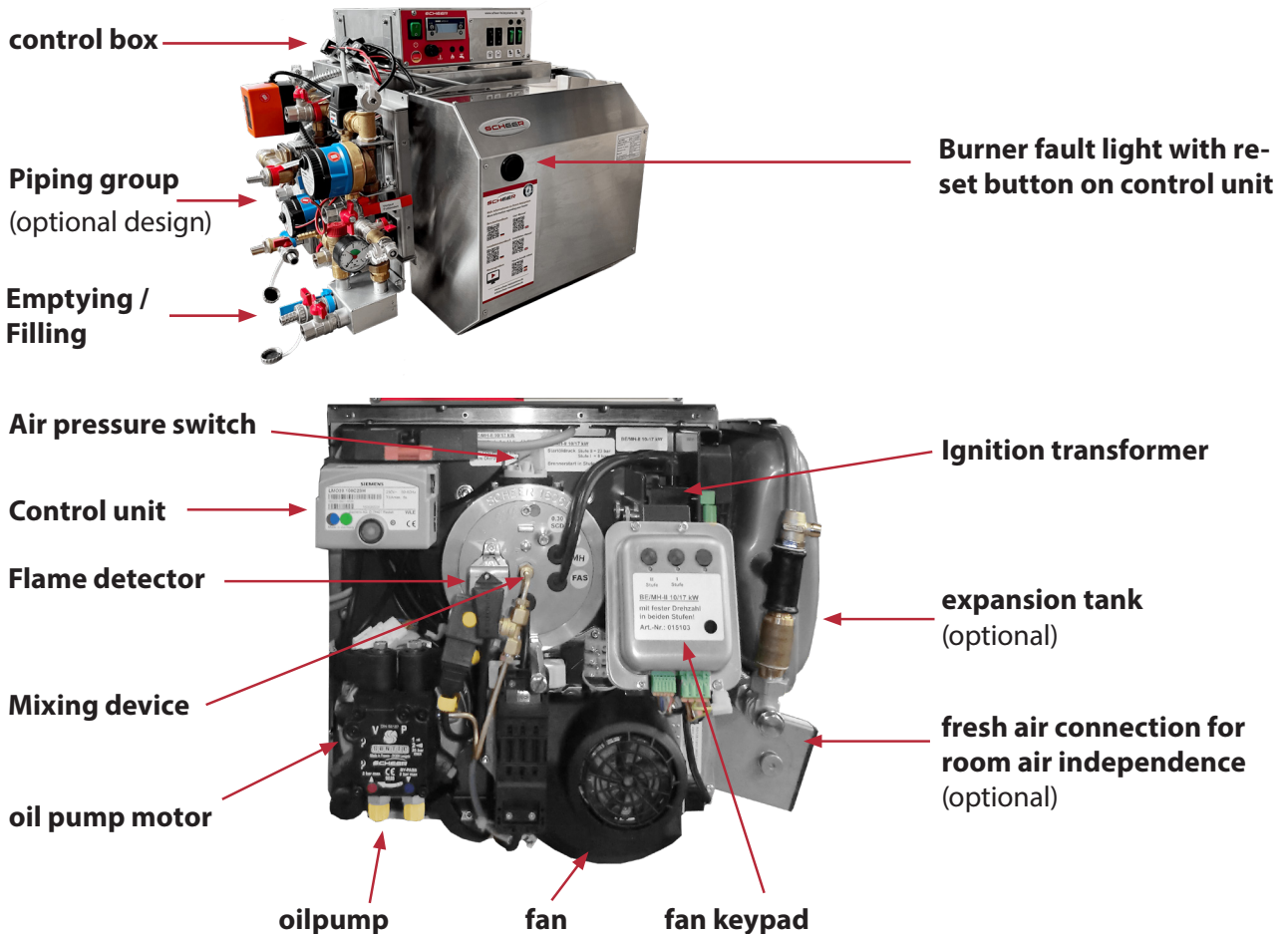

control box for MARELA-Series basic version

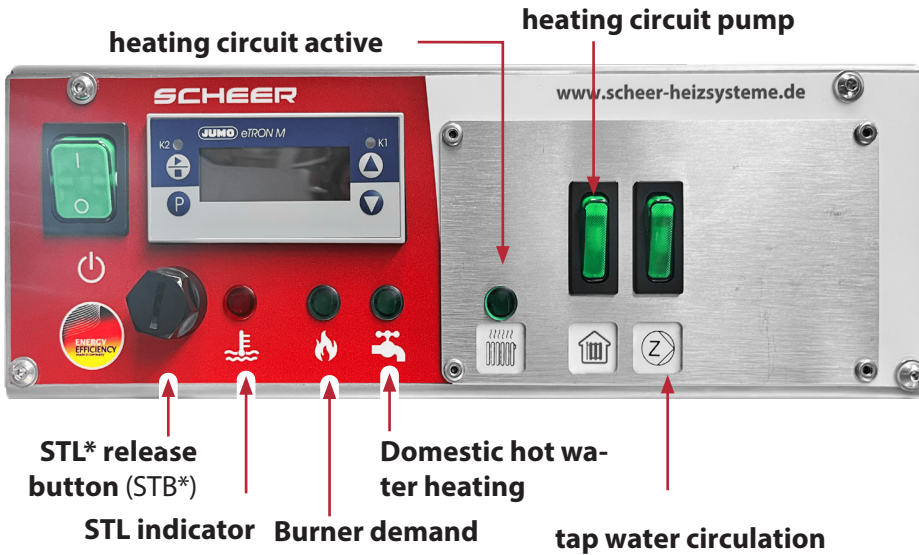

	Item No.
control box	0754480

* Safety temperature limiter

control box A for MARELA-Series full version

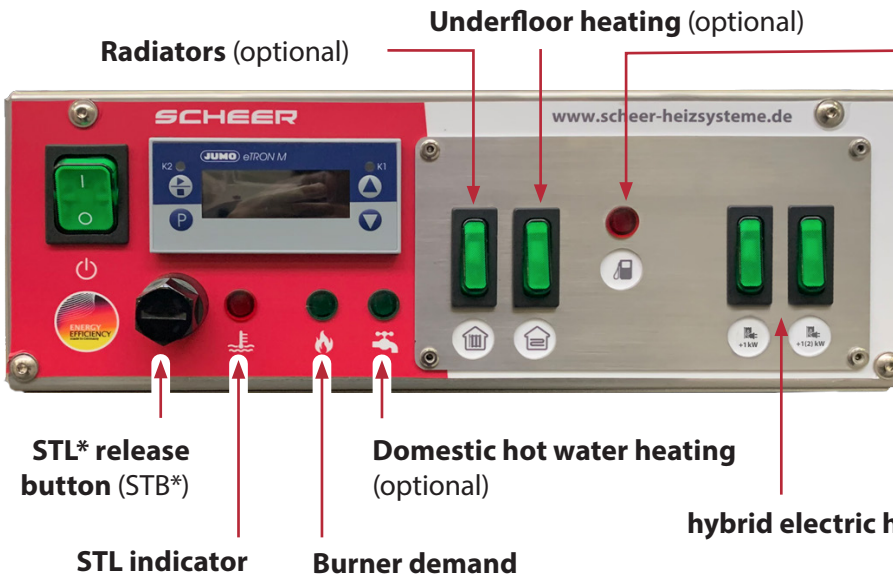

	Item No.
control box A	0754481

* Safety temperature limiter

Heating controller MARELA-Series



Symbol for heat request

pressureless system

heating: Set point 70°C Hysteresis 10°C
Domestic water: Set point 70°C Hysteresis 5°C

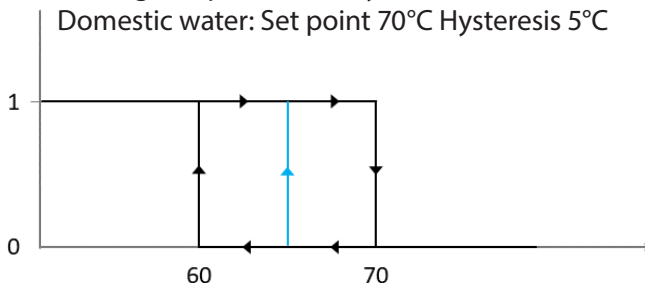

pressure system with expansion vessel

heating: Set point 70°C Hysteresis 5°C
Domestic water: Set point 78°C Hysteresis 5°C

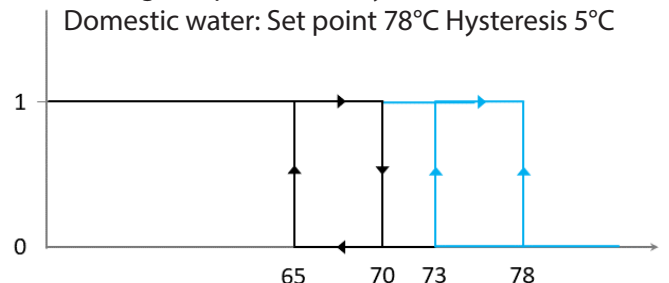

Interference lights

NOTICE:

warning lamp: burner

If the burner malfunction light is on continuously, a burner malfunction has occurred.

Press and hold the control unit's malfunction button for approx. 2 seconds, but not longer than 3 seconds, as this triggers the recall of the readout mode.

If the burner switches to malfunction twice again, please have it repaired by your specialist company. carried out by your specialist company.

Domestic hot water heating

The materials used for the plate heat exchangers are defined by DIN 1988 and are therefore approved for the fresh water sector. The quality design Alloy 316 with copper solder material is used.

In order to minimise corrosion, we recommend that the following limit values are observed for fresh hot water:

pH value:	7 - 9	
electr. conduction:	50 - 600 μ S/cm	
Chloride:	< 50	ppm
Iron:	< 0,5	ppm
free Chlorine:	< 0,5	ppm
Manganese:	< 0,05	ppm
Carbon dioxide:	< 10	ppm
Sulfate:	< 100	ppm
Phosphor:	< 2	ppm
Ammonia:	< 0,5	ppm
max. particle size:	0,5 mm	

NOTICE:

The plate heat exchanger should be completely drained during longer downtimes or if there is a risk of frost.

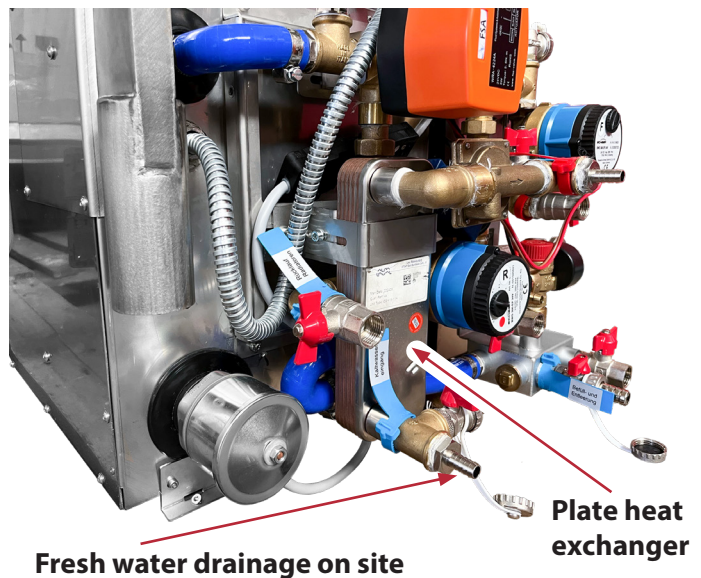

expansion tank (optional)



expansion tank

	Item No.
electric power 2 kW	036385
electric power 3 kW	036386
cover cap	036388

hybrid-heating with electric power (optional)

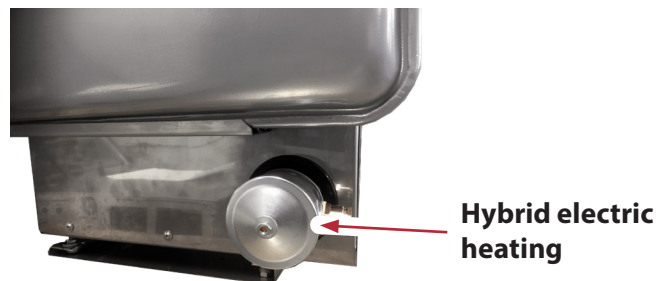

The hot water heating can be operated hybrid as an alternative to the operation with electric energy.

When the „Electric heating“ switch is activated, the operation of the burner is suspended. All control and protection functions of the other hot water heating remain in place.

How electric heating works



The 230V power supply of the electric heater must be supplied with voltage. 1kW or 2kW (see labelling) are activated summarily up to 3kW per switch, the corresponding switch lights up. The electric heater is controlled by the heat request signal of the thermostat. The indicator LEDs above the switches show whether the electric cartridge is currently heating.

NOTICE:

As long as the electric heater is switched on, the burner remains blocked, even if the voltage supply to the electric heater is interrupted. If the electric heater is switched on, the boiler thermostat indicates a heat request, but the indication LED is not lit, the voltage supply to the electric heater is interrupted.

Connection room thermostat with NO contact to MARELA series boiler

Das Wichtigste in Kürze

- Je verbautem Heizkreis kann ein Thermostat angeschlossen werden
- Durch einen Schließer-Kontakt im Thermostat wird die jeweilige Heizkreispumpe geschaltet
- Durch den 4-poligen Anschluss kann neben dem Schließer-Kontakt auch die 230V Spannungsversorgung des Thermostats verbunden werden
- Im Auslieferungszustand ist der Schließer-Kontakt gebrückt (Pumpe dauerhaft an)

Kontaktbelegung Steckverbinder MH

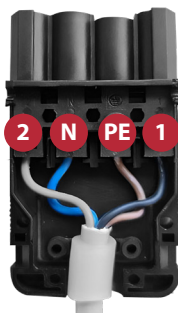

- 1 & 2** Schließer-Kontakt
- N** Nullleiter 230 V Thermostat-Spannungsversorgung
- Phase** 230V Thermostat-Spannungsversorgung

















Kontaktbelegung Raumthermostat



- 1 & 2** Schließer-Kontakt
- 3** Nullleiter 230V Thermostat-Spannungsversorgung
- 4** Phase 230V Thermostat-Spannungsversorgung
- 5 & 6** Anschluss externer Temperaturfühler

Overview of cable connections between components and control box

Colour marking / Connection type	Connected component
 BLUE	Fault switch (2-pole)
 WHITE	Electric heating (5-pole)
	Burner connection (7-pole)
	Request 2nd burner stage (4-pole)
	Connection to fresh water/radiators and pump
	Connection to floor heating circuit pump
	24V mains connection of the control box
	230V mains connection of the control box
	230V mains connection of the electric heater
 BROWN	Radiator heating circuit Room thermostat (4-pole) for connecting the room thermostat
 VIOLET	Floor heating circuit Room thermostat (4-pole) for connecting the room thermostat
 YELLOW - RED	Tank sensor (3-pole)
 GREEN POINT 	3-way valve (3-pole)

Antifreeze liquid for heating water (BIO-GLYKOL)

Ready-mix with minimum antifreeze -24°C

- Temperature stability 214°C
- Completely biodegradable
- Significantly longer shelf life than propylene glycol

Antifreeze components:

- 1.3 propanediol (100% plant derived)
- HTX1 approval for food related areas
- CO₂ reduced



	Item No.
30 liter canister	190090
1 liter bottle	190091

Oil supply / oil filter

NOTICE:

Failure to observe the installation condition can lead to malfunction or damage of equipment.

Automatic bleeders always have to be installed above the level of the oil pump.

At least 50% of the length of the fuel line should be ascendingly mounted.

Do not interchange the feed and return connection!

Note:

To maintain warranty the fuel burner must be equipped with an oil filter for a one-pipe system with return line, an automatic bleeder, and a micro filter.

The supplied silicone hose for the ventilator leads the air to the burner for combustion. This avoids diesel odors.

Use fuel lines with a **internal diameter of 6 mm (max. 10 mm) for the connection between the fuel tank and the oil filter.** Different diameters with the approval of the manufacturer only.

Unsupported fuel lines must be secured to prevent them from sagging. An oil filter is included in all basic packages.

NOTICE:

Repeated emptying of fuel tank can cause damage to the burner!

The **Tank Control option (Item no. 0170018/0170019)** is recommended as a preventive measure.



	Item No.
metal oil filter	040513
filter	040010

Note:

To maintain warranty the fuel burner must be equipped with an oil filter for a one-pipe system with return line, an automatic bleeder, and a micro filter.

The supplied silicone hose for the ventilator leads the air to the burner for combustion. This avoids diesel odors.

Use fuel lines with a **internal diameter of 6 mm (max. 10 mm) for the connection between the fuel tank and the oil filter.** Different diameters with the approval of the manufacturer only.

Unsupported fuel lines must be secured to prevent them from sagging. An oil filter is included in all basic packages.

Combustion air supply for MARELA - series

DANGER:

The air supplied to the combustion must never be taken from rooms where people are present. It must be arranged in such a way that it is not likely to become clogged with dirt, snow or water spray.

Permissible dimensions of the combustion air intake pipe:

- Inner diameter: 50 mm,
- Maximum permissible pipe length: 10 m
- Maximum permissible bends: 270 °

The combustion air intake must not be laid above the flue gas outlet and no closer than 50cm. Concentric air/flue gas system (LAS) is possible.

Exhaust pipe for MARELA-series

The mouth of the exhaust pipe must not point in the direction of travel.

The exhaust pipe mouth must be arranged in such a way that clogging by snow and mud is not to be expected.

Flexible or rigid pipes made of alloyed heat- and acid-resistant stainless steel are to be used as exhaust pipes.

The flue pipe is secured to the heater, e.g. with a clamp. For further regulations, see legal requirements.



exhaust pipe (flexible)	Item No.
Ø 35 mm	14-N000
Ø 50 mm	14-N246



Insulation hose	Item No.
Ø 35 mm, Ø 50 mm	14-N176

CAUTION:

If the flue gas pipe is laid outside the installation box near temperature-sensitive parts, it must be insulated! The flue gas outlet must not be laid below the combustion air inlet and no closer closer than 50 cm to each other.

Burner components

Flame detector



Flame detector	Item No.
Flame detector	020064

Oil hoses (pair)

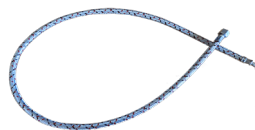

oil hoses (pair)	Item No.
oil hoses (pair)	0414180

The flame monitor evaluates the flame on the basis of its flicker frequency. This is done optically by the light tube end piece of the mixing device.

Display of the operating status:

LED off

Flame detector not active

LED flashes

Safety test carried out, flame monitor active, no flame present

LED lights up flickering

Safety test completed, flame monitor active, flame present

Oil pump motor



	Item No.
Oil pump motor	0151380
Condenser	010293

- Voltages below 200 V can cause the oil pump motor to stop!
- If the capacity of the capacitor deviates by more than 5 %, the capacitor must be replaced.

Radial fan



	Item No.
radial fan	015112

MH Serie

Fan control



	Item No.
MARELA 10/17	016026
MARELA 15/23	016027
MARELA 30/40	016028

The control board automatically adjusts the speed of the fan according to the atmospheric pressure (location of the vehicle) and thus sets an optimum combustion quality.

Oil pump



	Item No.
oil pump	011759

Two-stage oil pump (MH)

Ignition electrodes



	Item No.
MARELA 10/17	015110MH
MARELA 15/23	
MARELA 30/40	015114MH

Flame tube



	Item No.
MARELA 10/17	015329
MARELA 15/23	
MARELA 30/40	015331

Ignition transformer



	Item No.
air pressure switch	015188

The air pressure switch controls the pressure of the burner fan and is connected to the solenoid valve of the oil pump. Only when there is sufficient air pressure does the solenoid valve open so that the burning process can start.

Air pressure switch



	Item No.
ignition transformer	010276

Control unit



	Item No.
MARELA 10/17	0201020
MARELA 15/23	
MARELA 30/40	0201026

The release button is the central element for release, activation / deactivation and diagnosis.

The multi-coloured signal light in the release button is the central display element for visual diagnosis and interface diagnosis. During operation, the various states are displayed in the form of colour codes according to the colour code table.

Color code table for multicolor signal lamp (LED)

Status	Color code	Color
Waiting time, other waiting states	○.....	OFF
Waiting for release of prepurging / postpurging by oil pressure switch	●.....	Yellow
Ignition phase, ignition controlled	○●○●○●○●○●○●○	Flashing yellow
Operation, flame o.k.	■.....	Green
Operation, flame not o.k.	○■○■○■○■○■○■○	Flashing green
Extraneous light on burner startup	■▲■▲■▲■▲■▲■▲■▲	Green-red
Undervoltage	●▲●▲●▲●▲●▲●▲●▲	Yellow-red
Fault, alarm	▲.....	Red
Error code output (see Error code table)	○▲○▲○▲○▲○▲○▲○▲	Flashing red
Interface diagnostics	▲▲▲▲▲▲▲▲▲▲▲▲▲▲	Red flicker light

Table 6: Error code table

Legend

.....	Steady on	▲	Red
○	OFF	●	Yellow
		■	Green

Error code table of multicolor signal lamp (LED)

Red blink code of signal lamp (LED)	Alarm at terminal 10	Possible cause
2 blinks	ON	No establishment of flame at the end of safety time - faulty or soiled fuel valves - faulty or soiled flame detector - poor adjustment of burner, no fuel - faulty ignition equipment
3 x blinks	ON	Free
4 blinks	ON	Extraneous light on burner startup
5 blinks	ON	Free
6 blinks	ON	Free
7 blinks	ON	Too many losses of flame during operation (limitation of repetitions) - faulty or soiled fuel valves - faulty or soiled flame detector - poor adjustment of burner
8 x blinks	ON	Time supervision oil preheater - oil preheater failed 5 times during prepurging
9 blinks	ON	Free
10 blinks	OFF	Wiring error or internal error, output contacts, other fault

Pipe connection group components

Plate heat exchanger



	Item No.
Plate heat exchanger	036480

Circulating pump



	Item No.
circulation pump	0753112

Flow switch



	Item No.
3-way zone valve	065511

3-way zone valve



	Item No.
Flow switch	0362990

temperature sensor

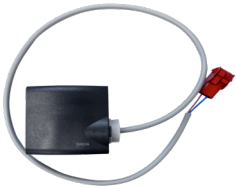

	Item No.
temperature sensor	0755130

Mixer



Automatic mixer for setting the flow temperatures

	Item No.
Automatic mixer MH series floor heating circuit (35°C - 60°C)	030400

Safety assembly



	Item No.
Safety group	0770650
Heating water pressure gauge	077066

boiler door cord



	Item No.
boiler door cord	0770650

Door and boiler insulation



	Item No.
MARELA 10/17	44-003
MARELA 15/23	47-004
MARELA 30/40	49-004

Door insulation

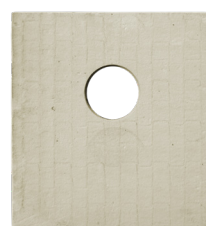

	Item No.
MARELA 10/17	44-004
MARELA 15/23	47-005
MARELA 30/40	49-005

Boiler insulation

Maintenance preparation

Prepare the maintenance work on the heating system as follows:

1. Cancel the heat request.
2. Wait 2 min. until the post-purge period is completed.
3. Switch off the water heater via the main switch on the control panel.
4. Unplug the connector from the 7-pin burner connector. The power supply to the burner is now interrupted.
5. Unplug the control panel connector from the socket. The power supply to the boiler is now interrupted.
6. Dismantle the burner from the boiler.
7. Carry out the steps for the maintenance work.
8. Reassemble all the dismantled parts after completing the maintenance work.

	maintenance interval
boiler cleaning	Optical inspection annually. When dirty clean with adequate cleaning kit. (non abrasive)
oil nozzle	Optical inspection annually. Use only genuine spare parts! Recommended exchange period: annually
ignition electrode	Optical inspection annually. Use only genuine spare parts! Recommended exchange period: annually
flame tube	Optical inspection annually. Use only genuine spare parts! Recommended exchange period: every three years
burner door: gasket and insulation	Inspect gasket and insulation optically every three years. Tighten up door screws. Recommended exchange: when needed.
exhaust emission check	After first installation, major repairs or every three years, if exhaust system is longer than 1.5m.
oil filter	Recommended exchange: annually or when the negative pressure is less than -0,30 bar (e.g. -0,35 bar).
oil hoses	Exchange period: every five years
radial fan	Recommended cleaning period: every three years. (depends on environment)
plate heat exchanger for fresh water (if mounted)	Cleaning period: every two years. (to avoid or to clean deposition)

Change oil filter



Change the filter cartridge of the oil filter (Item No. 040104) if the vacuum is too high and **less than -0.3 bar**.

ATTENTION:

Please dispose of the oil filter or filter cartridge in an environmentally friendly manner.

Clean boiler

ATTENTION:

Cleaning with liquids such as thinner or petrol and using brushes with metal bristles will cause corrosion.
Only use brushes or paintbrushes with plastic bristles for cleaning.
Do not use brushes or paintbrushes with metal bristles.
Sweep out and vacuum loose dust.

A well adjusted burner has soot-free combustion. This means that the boiler requires little cleaning.

A thin, light grey layer may be deposited in the combustion chamber. This is a sign of good combustion. **Do not remove this layer** as it acts like a preservative for the combustion chamber.

After you have dismantled the burner from the boiler, please follow these steps for cleaning the boiler.

Remove the insulation on the front of the kettle.

Only use brushes with plastic bristles (do not use metal bristles! The surfaces will otherwise be scratched).

Sweep the combustion chamber with the cleaning brush.

Sweep the front of the boiler with the cleaning brush or a hand brush.

Vacuum up any loose dust with a Hoover.

Refit the insulation.

Fit the burner to the boiler.

Set pump pressure

To set the pump pressure, a pressure gauge is plugged into the exhaust outlet.

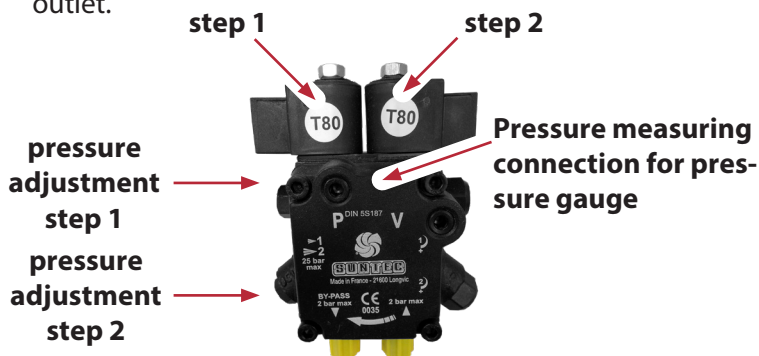

rush w. plastic bristles and cleaning brush

	Item No.
Cleaning set large	090327

mixing cartridge control

Mixing cartridge removal:

- Pull the plug of the flame detector. Pull the plug of the oil pre heater. Pull the two plugs of the ignition cable from the ignition transformer. The mixing cartridge is no longer connected to the burner.
- Loosen the mounting screws of the mixing cartridge. Due to the bayonet-mount it is not needed to remove the screws completely.
- Turn the mixing cartridge slightly to the left.
- Pull the mixing cartridge towards you and out of the burner.

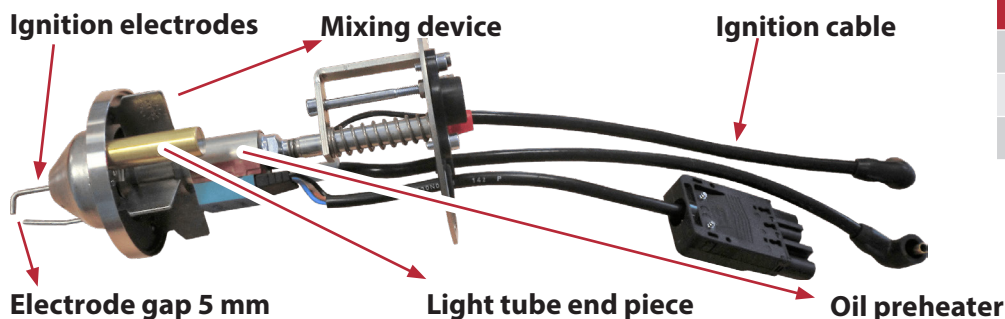

	Item No.
MARELA 10/17	0155517
MARELA 15/23	0155518
MARELA 30/40	0155515

Mixing cartridge control:

1. Check glass of the **flame detector tube** at the front end. Through this glass the flame detector monitors the condition of the burner flame. Clean the glass surface with burner cleaner and a soft cloth, if needed.
2. Check the **ignition electrodes**. If these are burned or not anymore properly placed in their holder replaced them with genuine SCHEER ignition electrodes.
3. Check for the correct distance of the ignition electrodes. The **distance between the two ignition electrodes must be 5 mm**. If the distance is greater or smaller than specified, they have to be replaced with genuine SCHEER ignition electrodes. (Do not bend the used electrodes they could break! Unused electrodes can slightly be bend to the correct distance.)
4. Check the **oil nozzle**. If the nozzle is damaged or deposits are present, it must be replaced. How to replace the nozzle is described in the next section.
5. Reinstall of the mixing cartridge in the reverse order of its removal.

nozzle

Note: Only take the oil nozzle out of the packaging directly before inserting it! The nozzle could otherwise be damaged.

Replace the oil nozzle in the following steps:

1. Loosen the set screw of the mixing device. Pull off the mixing device from the oil pre heater. The oil nozzle is now exposed.
2. Loosen the old oil nozzle with a 16 mm box-end wrench while holding the oil pre heater with a 16 mm open-end wrench.
Do not use an open ended wrench for the nozzle to avoid damage.
3. Take the new nozzle out of the package. Hold the nozzle only by the sides of its hexagon and screw it by hand.
4. Hand tighten the oil nozzle with a 16 mm box-end wrench while holding the oil pre heater with a 16 mm open-end wrench. Do not use excessive force or an open-end wrench to avoid damage to the nozzles hexagon.
5. Slide the mixing device back over the oil pre heater. The oil nozzles and the air bushing must be at the same height level. Use a plane non-metal surface to align the position of the nozzle with the height of the air bushing. Do not use a metal surface to avoid damage to the nozzle. **If the oil nozzle is not on the same level with the air bushing the burner will not work correctly.**
6. Make sure that the light detector tube and the flame detector are in line with each other. An axial rotation will lead to no flame detection and malfunction shut down.
7. Now hand-tight the set screw of the mixing device. Do not use excessive force! Too much force will deform the surface of the nozzle holder and an exact positioning of the mixing device is no longer possible.
8. Remount the mixing cartridge in the reverse order.

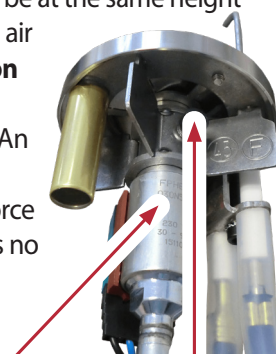

Oil preheater Locking screw

	Oil nozzle	Item No.
MARELA 10 / 17	0.30/60° SCD	022380
MARELA 15 / 23	0.35/60° SCD	022378
MARELA 30 / 40	0.65/60° SCD	022377

Electrical schematics of controller

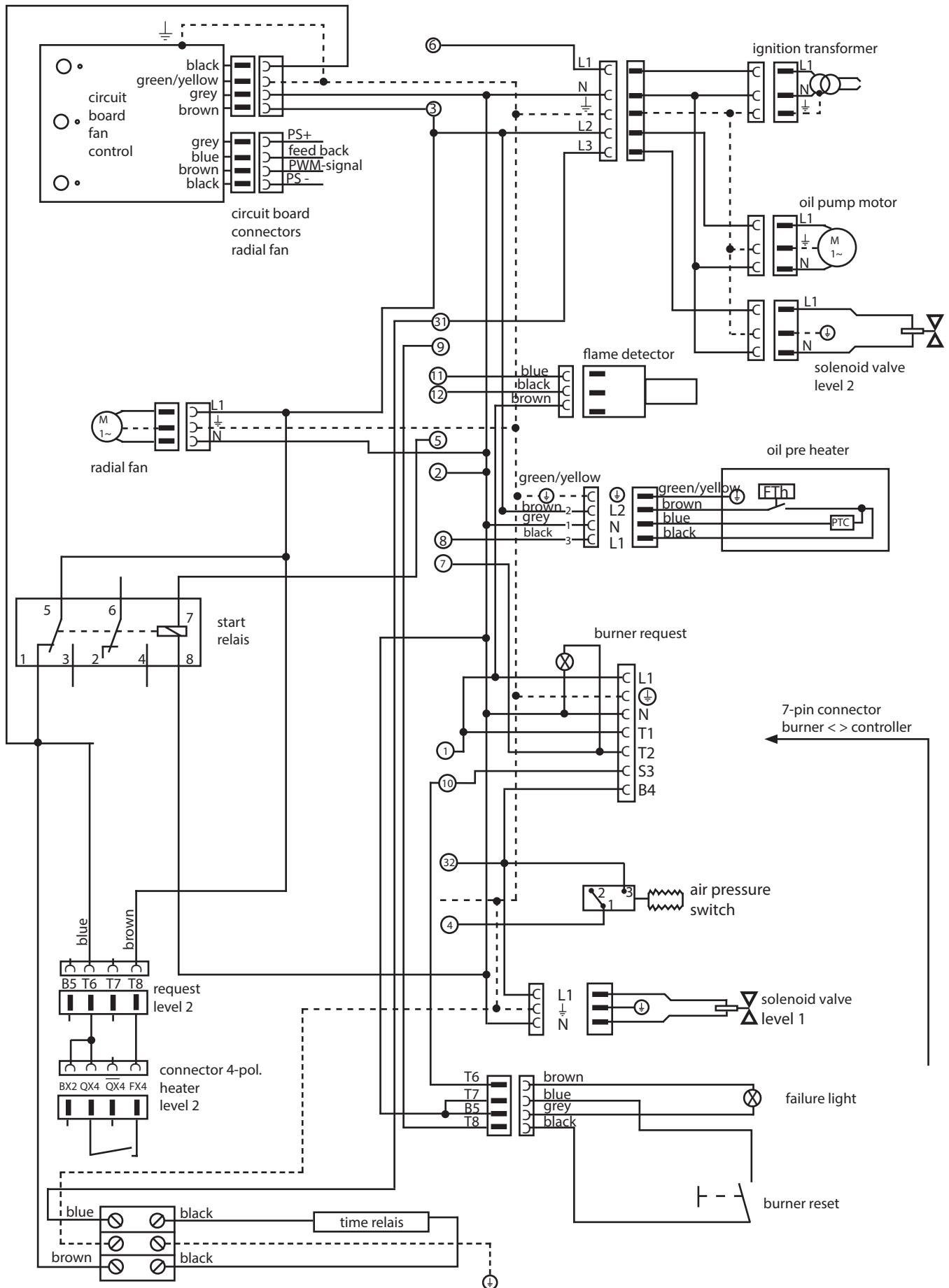

Room thermostat - WLAN (optional)

Room thermostat



Please read these operating instructions for all information on the installation and operation of your thermostat. Ensure that the thermostat is installed and connected by a professionally qualified person and that it complies with all regional regulations.

In the box you will find:

- 1x Thermostat
- 1x QC Passed
- 2x Screws
- 1x external Floor Sensor (2.5m)

Room thermostat	Item No.
incl. WLAN connection	0170106

About the thermostat

The thermostat has been developed to control industrial, commercial, civil or domestic hot water heating systems, such as radiators or underfloor heating.

functions

- Networking through Modbus and WLAN
- 0.5 °C given
- Short-term memory in the event of a power failure
- 5 + 1 + 1 weekly program with 6 periods comprehensive time program
- Controllable by Amazon Echo, Google Home, Tmall Genie

Dimensions

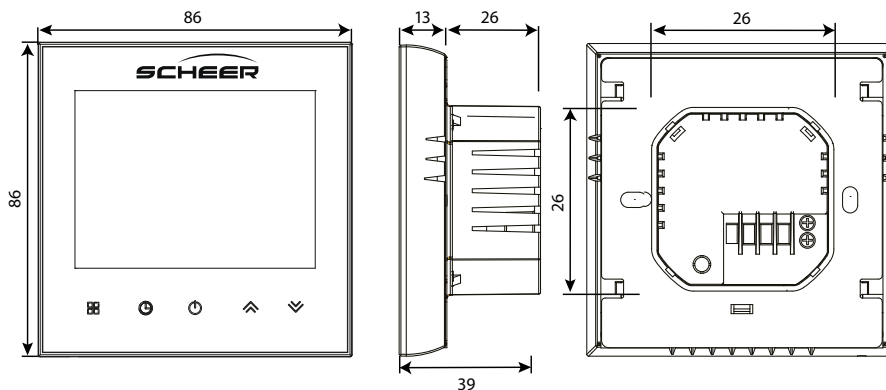

Technical Data

Power Supply	95~240VAC, 50~60Hz	Timing error	<1%
Current Load max	5A	Shell Material	PC + ABS (fire proof)
Sensor	NTC3950, 10k	Installation Box	86x86mm square/ Europ. 60mm round
Accuracy	±0,5°C	Wire Terminals	2*1,5mm ² / 1x2,5mm ²
Set Temp. Range:	5-35°C	Protection Class	IP20
Display Temp. Range	5~99°C	Storage Temp	-5~45°C
Ambient Temp.:	0~45°C	Power Consumption	<1,5W
Ambient Humidity:	5~95% RH (not condensing)		

Installation

NOTICE

Before starting the installation, make sure that the power supply and all other connecting cables are voltage-free!

Your thermostat is suitable for installation inside a standard 86 mm junction box or a European 60 mm junction box.

Step 1

Keep power off.

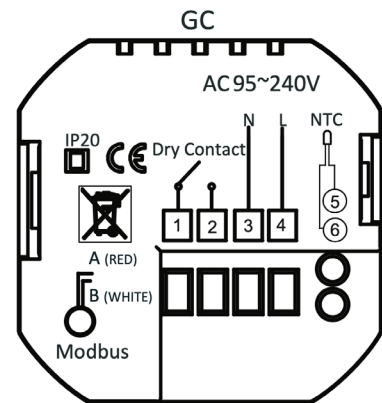
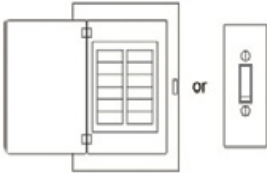

Step 2

Remove the mounting Plate by rotating the LCD part.

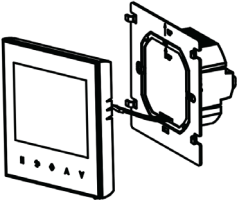

Step 3

Connect the power supply to the corresponding terminals of the thermostat (L - phase; N - neutral); connect the switching contacts to terminals 1 and 2.

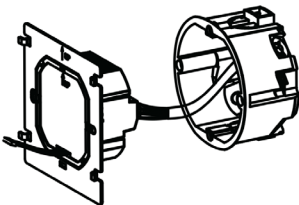

Step 4

Fix the mounting plate to the wall using the screws supplied.

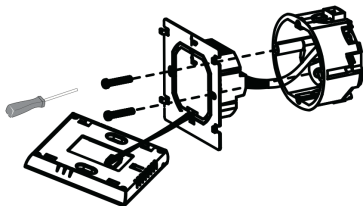

Step 5

Attach the LCD part of the thermostat to the mounting plate by rotating it, Installation complete.

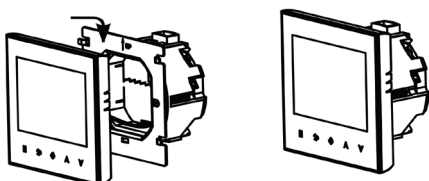

Homescreen quick reference

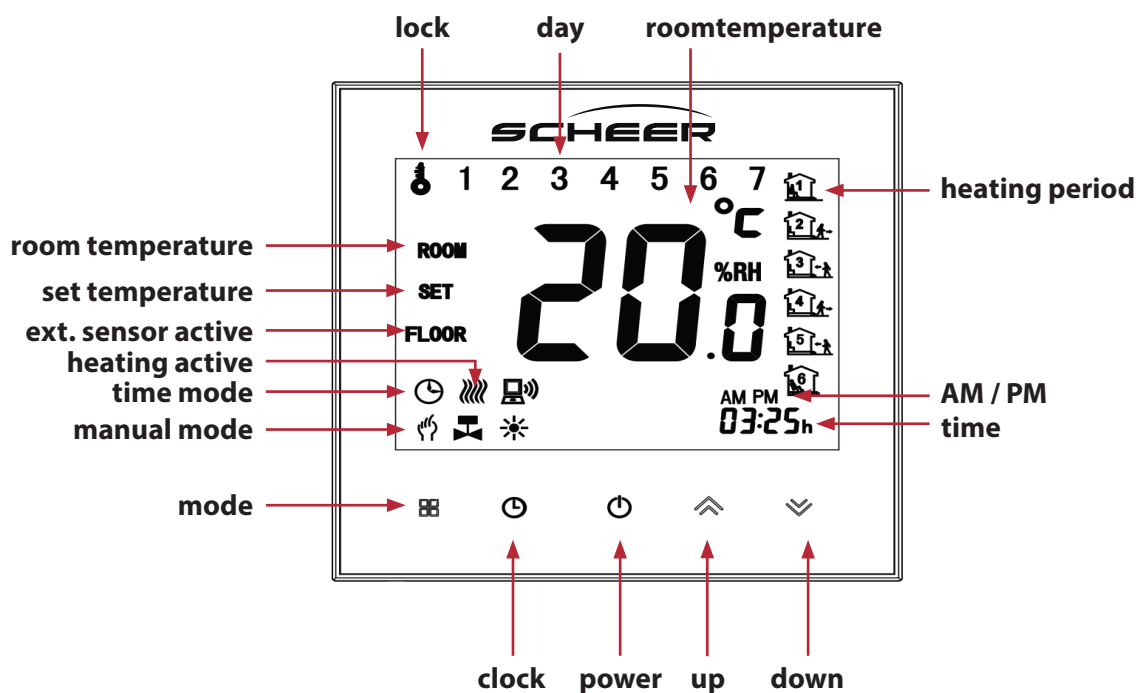

operation

- 1. Power on/off:** Press to turn the thermostat on/off.
- 2. Manual/ Time program mode:** Touch to change between manual mode and program mode. In manual mode, will show in the bottom left of the screen. In programmable mode, the period icon will show on the right side.
- 3. Setting Temperature:** In the time program mode the temperature can only be controlled by the set heating program. In the manual mode, press to set the desired temperature.
- 4. Adjusting/Setting the Clock:** Touch the to set minute, hour and weekday (1 = Monday, 2 = Tuesday etc.) by using the arrows. Press once more to confirm and exit.
- 5. Locking your Thermostat:** Press and hold the for 5 seconds to lock/unlock your thermostat. In item 3 of the device parameters, you can select full lock (included).
- 6. Adjusting/setting the Program Schedules:** When Wi-Fi connection is made, your thermostat will automatically accept the program schedule made via the APP on your device (see below for detailed instructions) To set the program schedules through your thermostat (NOT via your smartphone/tablet) simply follow the instructions as below:
Please note: Setting the programme schedule through your thermostat can only be carried out if there is no Wi-Fi connection between your thermostat and smartphone/tablet
- 7. Setting / adapting the time program on the thermostat:** The time program can only be set on the device if there is no active WLAN connection and time program mode is activated. Touch to change between manual/ time program mode. In program mode, touch and hold the icon until the weekday schedule settings appear (1 2 3 4 5 will show along the top of the screen). Use the arrows to adjust the „on“ time.
 Press the icon and use the arrows to set the off time (2nd period).
 Press the icon and use the arrows to set the temp. Repeat this process for periods 3 - 6.
 Press the icon once more to enter the Saturday schedule settings (6 will show along the top of the screen). Repeat the above process to set the periods as well as temp. as well as Sunday schedule. Press once more to confirm and exit.





Default settings for program schedule

heating periode	weekday (Monday-Friday) (1 2 3 4 5)		Weekend (Saturday) 6		Weekend (Sunday) 7	
	time	temperature	time	temperatur	time	temperatur
period 1	06:00 AM	20°C	06:00 AM	20°C	06:00 AM	20°C
period 2	08:00 AM	15°C	08:00 AM	20°C	08:00 AM	20°C
period 3	11:30 AM	15°C	11:30 AM	20°C	11:30 AM	20°C
period 4	01:30 PM	15°C	01:30 PM	20°C	01:30 PM	20°C
period 5	05:00 PM	22°C	05:00 PM	20°C	05:00 PM	20°C
period 6	10:00 PM	15°C	10:00 PM	15°C	10:00 PM	15°C

A separate schedule may be set for weekdays (Mon - Fri) and for weekends (Sat or Sun).

Change the system settings

Turn off the device.

Press  and  at the same time for 5 seconds to get to the system settings. Then press  to cycle through the available settings and use   to change the parameter values. All changes will be saved automatically.

code	function	setting an options	default
1	temperature compensation	-7 bis +9°C {for internal sensor}	-1
2	deadzone temperature	1-5°C	1
3	button locking	00: all buttons locked except on/off 01: all buttons locked	01
4	sensor types	In: Internal Sensor (to control the temp.) Ou: External Sensor (to control the temp.) AL: Internal/ External Sensor (Internal sensor to control the temp., external sensor to limit the floor temp.)	AL
5	min. set tempature	5-15°C	05
6	max. set temperature	15-45 °C	35
7	display mode	00: display of set temp. and room temp. 01: display of only set temp.	00
8	low temperature protection setting	0-10°C	00
9	high temprature protection setting	25-70°C	45
A	economy mode	00: non-energy saving mode 01: energy saving mode	0
B	economy temprature	0-30°C	20
C	standby brightness	3-99	20

Here is some place
 for your SCHEER-
 identification-plate:



service protocol

The guarantee is only valid if the complete protocol is completed!

Send the completed protocol to info@scheer-heizsysteme.de or by mail to
 SCHEER Heizsysteme & Produktionstechnik GmbH | Chausseestraße 16 | D-25797 Wöhrden | Germany

customer : _____
 street : _____
 postcode : _____ place : _____
 country : _____
 phone number : _____ E-Mail address : _____
 type of boiler : _____ serial number : _____
 type of burner : _____ serial number : _____

burner protocol	yes	no	not true	comment:
Burner mounting flange tested, Marking upwards	<input type="checkbox"/>	<input type="checkbox"/>	<input type="checkbox"/>	
burner installation depth (HR, B, B-tap)	<input type="checkbox"/>	<input type="checkbox"/>	<input type="checkbox"/>	
oil nozzle checked	<input type="checkbox"/>	<input type="checkbox"/>	<input type="checkbox"/>	
Ignition electrode checked	<input type="checkbox"/>	<input type="checkbox"/>	<input type="checkbox"/>	
position of the baffle plate / mixing device checked	<input type="checkbox"/>	<input type="checkbox"/>	<input type="checkbox"/>	
oil pump venting and oil pump pressure checked	<input type="checkbox"/>	<input type="checkbox"/>	<input type="checkbox"/>	
air dumper setting checked (HR, B, B-tap, Compact 7, W1)	<input type="checkbox"/>	<input type="checkbox"/>	<input type="checkbox"/>	
fuel line checked for leakage	<input type="checkbox"/>	<input type="checkbox"/>	<input type="checkbox"/>	
forward and return flow of the oil hoses checked	<input type="checkbox"/>	<input type="checkbox"/>	<input type="checkbox"/>	
inner diameter of the fuel line (min. 6 - max. 10mm)	<input type="checkbox"/>	<input type="checkbox"/>	<input type="checkbox"/>	
oil filter positioned above the oil pump	<input type="checkbox"/>	<input type="checkbox"/>	<input type="checkbox"/>	
external air supply available	<input type="checkbox"/>	<input type="checkbox"/>	<input type="checkbox"/>	

boiler protocol	yes	no	not true	comment:
boiler installed and secured	<input type="checkbox"/>	<input type="checkbox"/>	<input type="checkbox"/>	
ventilation valves available in the system	<input type="checkbox"/>	<input type="checkbox"/>	<input type="checkbox"/>	
hydraulic pressure in the system (mind. 1 - max. 2 bar)	<input type="checkbox"/>	<input type="checkbox"/>	<input type="checkbox"/>	
expantion tank available (min. 10% water capacity)	<input type="checkbox"/>	<input type="checkbox"/>	<input type="checkbox"/>	
run the circulation pump for 3 minutes in deaerator mode (only Wilo-pumps)	<input type="checkbox"/>	<input type="checkbox"/>	<input type="checkbox"/>	
check fresh water and set to litres per minute (pre-installed on MH)	<input type="checkbox"/>	<input type="checkbox"/>	<input type="checkbox"/>	
control panel with all function checked	<input type="checkbox"/>	<input type="checkbox"/>	<input type="checkbox"/>	
function of the room thermostat checked	<input type="checkbox"/>	<input type="checkbox"/>	<input type="checkbox"/>	
boiler door / mounting plate secured	<input type="checkbox"/>	<input type="checkbox"/>	<input type="checkbox"/>	
boiler and door insulation checked	<input type="checkbox"/>	<input type="checkbox"/>	<input type="checkbox"/>	
combustion chamber insert / efficiency checked (HR / B25 / B35 / B45 / KB20)	<input type="checkbox"/>	<input type="checkbox"/>	<input type="checkbox"/>	
exhaust system checked	<input type="checkbox"/>	<input type="checkbox"/>	<input type="checkbox"/>	
condensation control available (KB and longer than 3 meters of chimney)	<input type="checkbox"/>	<input type="checkbox"/>	<input type="checkbox"/>	
boiler thermostat checked - Switch-off at set boiler temperature	<input type="checkbox"/>	<input type="checkbox"/>	<input type="checkbox"/>	

test measurement protocol		
exhaust gas measurement between 60-65 °C boiler temperature		
	figure:	comment:
CO ₂ (MH, MA, KB, B1, B2, W1) - setting values see burner	%	
CO ₂ (HR, B, B-tap, Compact 7) - settomg values between 11,5 - 12,5 %	%	
CO (<40 ppm)	ppm	
smoke gas temperature (<300 °C)	°C	
soot value (0-1)		

date / place : _____

customer _____ signature : _____ name : _____	mechanic company : _____ phone number : _____ E-Mail : _____ signature : _____ name : _____
---	---

Installation and maintenance instructions

MARELA-Serie water heater

SCHEER
Heizsysteme & Produktionstechnik GmbH
Chausseestr. 16
D-25797 Wöhrden
Tel.: + 49 (0) 4839 / 905-0
Fax.: +49 (0) 4839 / 453
info@scheer-heizsysteme.de
www.scheer-heizsysteme.de